

4				
3	Screw	Steel	Ni	M3.5
2	Terminal	Brass	TIN	1/2H
1	Base	PBT		UL94 V-0
A	Part Name	Material	Plating	Remark

Current rating	AC250V 10Amp
Insulation resistance	1000M Ohms of More at DC500V
Withstand voltage	AC2000V/Minute
Wire range	AWG #14~#22
Torque	6.9 lb-in

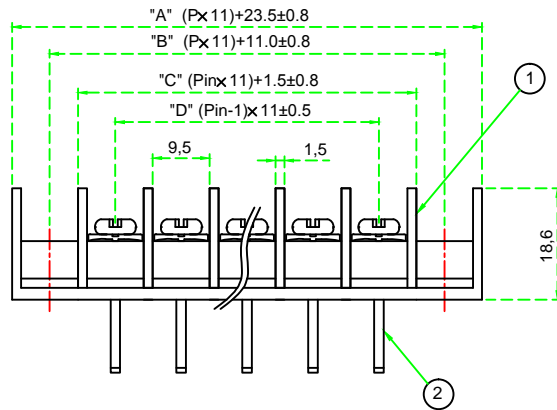

(A Type)
<Standard>

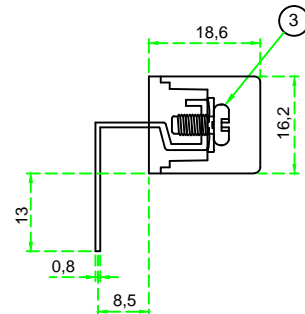
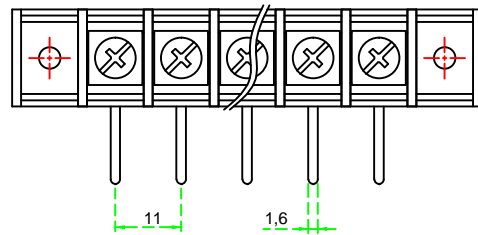

(B Type)

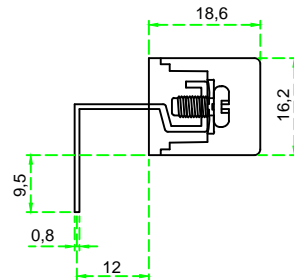
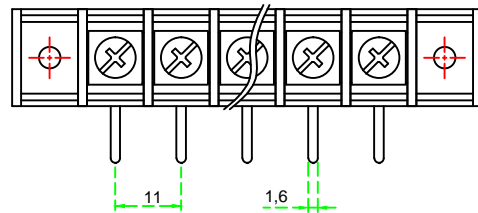

(C Type)

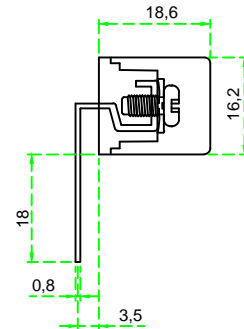
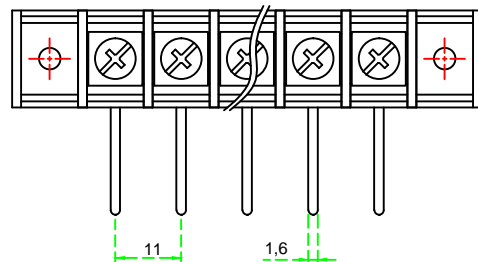

(Option)

1. Cover 사용시 No: BI-11A-2LFC-※P

PCB hole Dia: Ø2.0

(Note)

2. 지시하지 않은 공차: GENERAL TOLERANCES

GENERAL TOLERANCES		Part Name.		Dwg No.	
0 ~ 50	±0.5	Terminal block		BI-11A-2LF-※P	
50 ~ 100	±0.8				
100 ~ 150	±1.0	Drawing BY.	Checkd BY.	Approval BY.	Sheet No.
150 ~ 200	±1.2				of
Scale	/	(주)부일일렉트로닉스 BUIL ELECTRONICS CO., LTD. www.ebuil.com			
Material					
Finish					